

**811A  
842  
555  
531B  
532B  
500A MONO**

**Service Note**

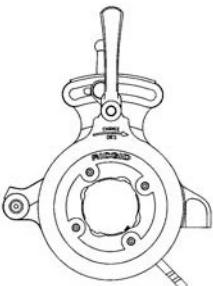

†2 Retaining Ring must be oriented as shown for proper oil flow.

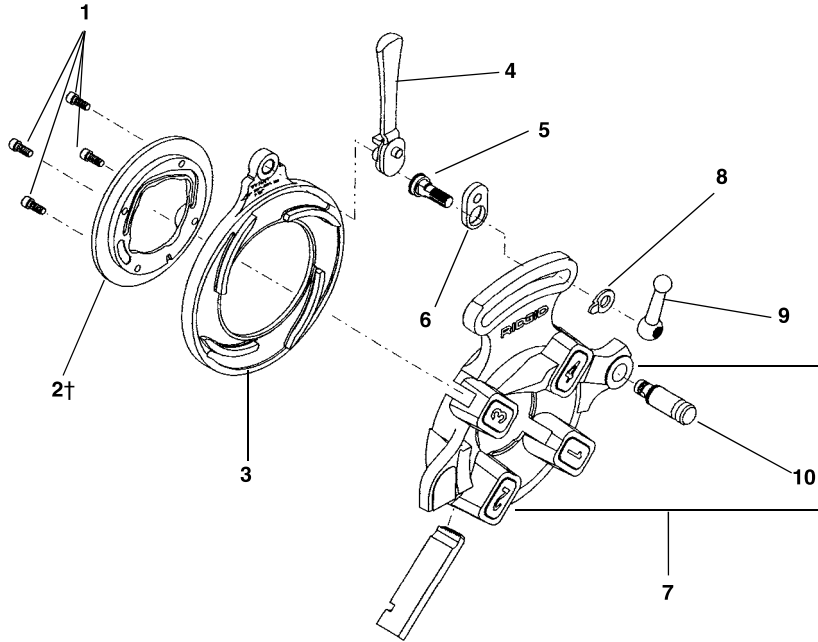

**QUICK OPENING DIE HEADS**

**NOTE: Order parts by Catalog Number only. DO NOT order by Reference Number.**

Ref. No.	1	2†	3	4	5	6	7	8	9	10
Die Head & Catalog No.	Screw	Retaining Ring	Cam Plate	Throw-Out Lever	Lock Screw	Link	Head/w Post	Lever Washer	Clamp Lever	Post
811A (97065) 1/8"-2" RH NPT	32205	97020	43360	46520	39860	39950	40922	26957	39970	59832
842 (23282) 1/8"-2" LH NPT	32205	23292	43360	46520	39860	39950	23287	26957	39970	59832
555 (10491) 1/8"-3/4"	32205	24256	43365	46555	39860	39950	24006	26957	39970	59832
531B (97045) 1/2"-1" RH/LH	32205	46620	43405	46555	39955	39950	97055	26957	39970	59832
532B (97050) 1 1/8"-2" RH/LH	32205	46625	43410	46555	39955	39950	97060	26957	39970	59832
811A (97070) 1/8"-2" BSPT	32205	97020	43360	46520	39860	39950	40957	26957	39970	59832
842 (23297) 1/8"-2" LH (BSPT)	32205	23292	43360	46520	39860	39950	23202	26957	39970	59832
500A Mono (1/8"-3/8") RH 1/8" (41032) 1/4" (41037) 3/8" (41042)	32205	1/8"-41862 1/4"-41867 3/8"-41872	43305	46555	47140	39950	41907	26957	46820*	59832
500A Mono (1/2"-3/4") RH 1/2" (41047) 3/4" (41062)	32205	1/2"-41877 3/4"-41882	43300	46555	47140	39950	41912	26957	46820*	59832
500A Mono (1"-1 1/4") RH 1" (41057) 1 1/4" (41062)	32205	1"-41887 1 1/4"-41892	43295	46555	47140	39950	41917	26957	46820*	59832
500A Mono (1 1/2"-2") RH 1 1/2" (41067) 2" (41072)	32205	1 1/2"-41897 2"-41902	43290	46555	47140	39950	41922	26957	46820*	59832

\*Hex Nut For Mono Die Heads